

1. kapitola

System Ekoplastik



Výhody systému

- ⊕ kompletní sortiment trubek a tvarovek v dimenzích 16 – 125 mm
- ⊕ univerzální tvarovky pro všechny typy trubek v Systému Ekoplastik
- ⊕ vyrobeno z granulátu od předních evropských výrobců
- ⊕ unikátní třívrstvá trubka s čedičovým vláknem
- ⊕ polypropylen nové generace PP-RCT (typ 4)

Základní informace o Systému Ekoplastik

Přehled a použití systému



	PPR PN 10	PPR PN 16	PPR PN 20	EVO	STABI PLUS	FIBER BASALT CLIMA	FIBER BASALT PLUS
	Ø 20 –125 mm	Ø 16 –125 mm	Ø 16 –125 mm	Ø 16 –125 mm	Ø 16 –110 mm	Ø 20 –125 mm	Ø 20 –125 mm



max. 70 °C



max. 90 °C



Vícevrstvé potrubí nové generace – PP-RCT

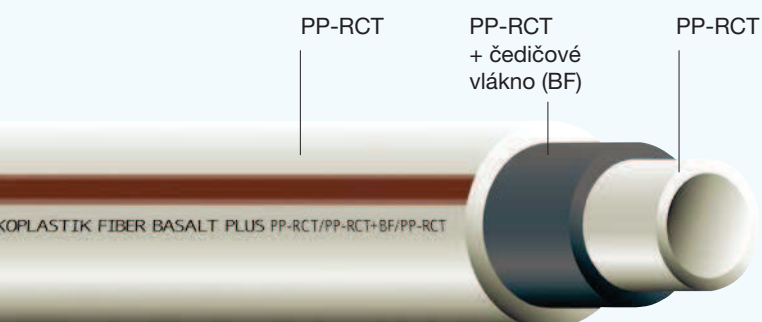

FIBER BASALT PLUS

- 3× nižší délková roztažnost než celoplastová trubka PPR
- bez nutnosti ořezu před svařováním
- vhodná i pro vytápění

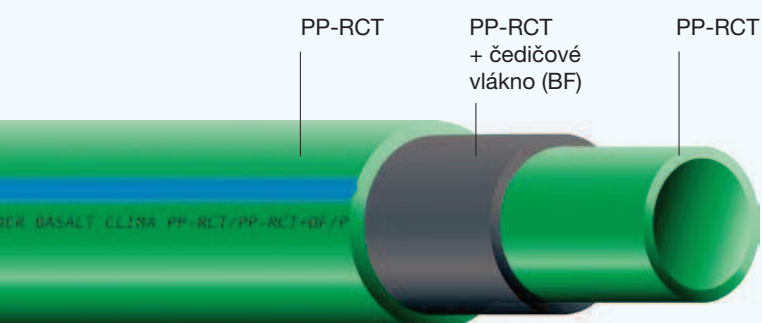

FIBER BASALT CLIMA

- 3× nižší délková roztažnost než celoplastová trubka PPR
- bez nutnosti ořezu před svařováním
- pro rozvody chladicí vody a klimatizace

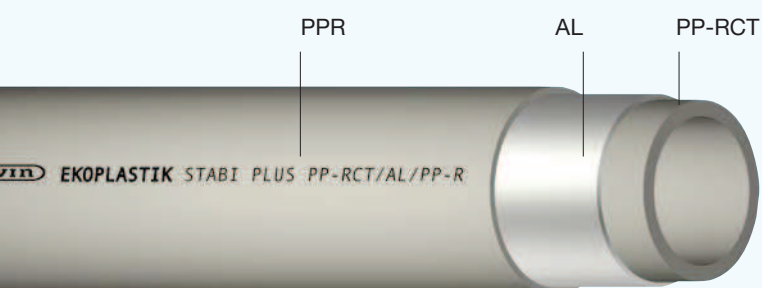

STABI PLUS

- 3× nižší délková roztažnost než celoplastová trubka PPR
- kyslíková bariéra
- speciálně pro vytápění

Rozvody studené (pitné) vody, teplé vody a vytápění (standardní, I.)



Trubka S 5 / PN 10 / SDR 11

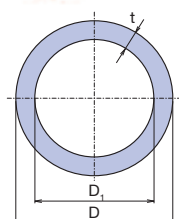

D mm	D ₁ mm	t mm	l mm	Balení m	Váha kg/m	KÓD
20	15,6	2,2	4 000	100	0,121	STR020P10X
25	20,4	2,3	4 000	60	0,164	STR025P10X
32	26,2	2,9	4 000	40	0,258	STR032P10X
40	32,6	3,7	4 000	24	0,413	STR040P10X
50	40,8	4,6	4 000	16	0,636	STR050P10X
63	51,4	5,8	4 000	12	1,004	STR063P10X
75	61,4	6,8	4 000	8	1,401	STR075P10X
90	73,6	8,2	4 000	4	2,014	STR090P10X
110	90,0	10,0	4 000	4	3,009	STR110P10X
125	102,2	11,4	4 000	4	3,910	STR125P10X



Trubka S 3,2 / PN 16 / SDR 7,4

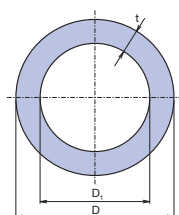

D mm	D ₁ mm	t mm	l mm	Balení m	Váha kg/m	KÓD
16	11,6	2,2	4 000	160	0,094	STR016P16X
20	14,4	2,8	4 000	100	0,145	STR020P16X
25	18,0	3,5	4 000	60	0,227	STR025P16X
32	23,2	4,4	4 000	40	0,367	STR032P16X
40	29,0	5,5	4 000	24	0,566	STR040P16X
50	36,2	6,9	4 000	16	0,886	STR050P16X
63	45,8	8,6	4 000	12	1,387	STR063P16X
75	54,4	10,3	4 000	8	1,990	STR075P16X
90	65,4	12,3	4 000	4	2,839	STR090P16X
110	79,8	15,1	4 000	4	4,274	STR110P16X
125	90,8	17,1	4 000	4	5,530	STR125P16X



Trubka S 2,5 / PN 20 / SDR 6

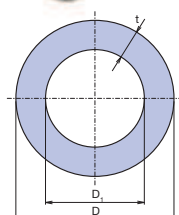

D mm	D ₁ mm	t mm	l mm	Balení m	Váha kg/m	KÓD
16	10,6	2,7	4 000	160	0,107	STR016P20X
20	13,2	3,4	4 000	100	0,169	STR020P20X
25	16,6	4,2	4 000	60	0,259	STR025P20X
32	21,2	5,4	4 000	40	0,423	STR032P20X
40	26,6	6,7	4 000	24	0,657	STR040P20X
50	33,4	8,3	4 000	16	1,013	STR050P20X
63	42,0	10,5	4 000	12	1,611	STR063P20X
75	50,0	12,5	4 000	8	2,288	STR075P20X
90	60,0	15,0	4 000	4	3,332	STR090P20X
110	73,4	18,3	4 000	4	4,977	STR110P20X
125	83,4	20,8	4 000	4	6,470	STR125P20X

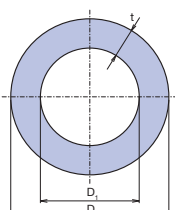
Trubka S 2,5 / PN 20 / SDR 6 – délka 3 m

D mm	D ₁ mm	t mm	l mm	Balení m	Váha kg/m	KÓD
20	13,2	3,4	3 000	75	0,169	STR020P203
25	16,6	4,2	3 000	45	0,259	STR025P203
32	21,2	5,4	3 000	30	0,423	STR032P203

Výše uvedené trubky lze po předchozím projednání vyrobit i v jiných délkách, než jsou uvedeny v katalogu.

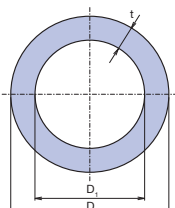
Novinka
Trubka EVO S 3,2 / SDR 7,4 PN 28 (výpočet)

D mm	D ₁ mm	t mm	l mm	Balení m	Váha kg/m	KÓD
16	11,6	2,2	4 000	160	0,095	STRE016S32

Trubka EVO S 4 / SDR 9 PN 22 (výpočet)

20	15,4	2,3	4 000	100	0,127	STRE020S4
25	19,4	2,8	4 000	60	0,191	STRE025S4
32	24,8	3,6	4 000	40	0,313	STRE032S4
40	31,0	4,5	4 000	24	0,487	STRE040S4
50	38,8	5,6	4 000	16	0,755	STRE050S4
63	48,8	7,1	4 000	12	1,200	STRE063S4
75	58,2	8,4	4 000	8	1,690	STRE075S4
90	69,8	10,1	4 000	4	2,440	STRE090S4
110	85,4	12,3	4 000	4	3,620	STRE110S4
125	97,0	14	4 000	4	4,660	STRE125S4

Pro optimální svár je nutné dodržet – dobu prohřívání dle průměru potrubí a svařovací teplotu 260 °C.

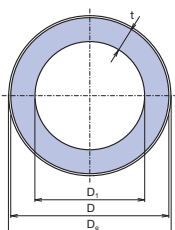
Trubka STABI PLUS S 3,2 / SDR 7,4 PN 28 (výpočet) s neperforovanou fólií

D mm	D _e mm	D ₁ mm	t mm	l mm	Balení m	Váha kg/m	KÓD
16	17,9	11,4	2,2	4 000	120	0,137	STRS016RCT
20	21,9	14,4	2,8	4 000	80	0,207	STRS020RCT
25	26,9	18,0	3,5	4 000	60	0,298	STRS025RCT
32	33,9	23,2	4,4	4 000	40	0,465	STRS032RCT
40	41,9	29,0	5,5	4 000	20	0,692	STRS040RCT
50	52,0	36,2	6,9	4 000	16	1,046	STRS050RCT
63	65,0	45,8	8,6	4 000	8	1,587	STRS063RCT

Trubka STABI PLUS S 4 / SDR 9 PN 22 (výpočet) s perforovanou fólií

75	77,0	58,2	8,4	4 000	8	1,860	STRS075RCT
90	92,0	69,8	10,1	4 000	4	2,673	STRS090RCT
110	112,0	85,4	12,3	4 000	4	4,022	STRS110RCT

Trubky STABI PLUS jsou dle tloušťky stěny označeny třídou „S“. Zastaralé označování trubek „PN“ nelze pro nový materiál PP-RCT použít, neboť trubky z tohoto materiálu mají lepší provozní parametry (tlak, teplota, životnost) než trubky z PPR.

Rozvody studené (pitné) vody, teplé vody a vytápění (standardní, I.)

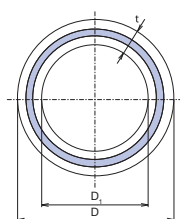

Trubka FIBER BASALT PLUS S 3,2 / SDR 7,4 PN 28 (výpočet)

D mm	D ₁ mm	t mm	l mm	Balení m	Váha kg/m	KÓD
20	14,4	2,8	4 000	100	0,153	STRFB020TRCT
25	18,0	3,5	4 000	60	0,239	STRFB025TRCT
32	23,2	4,4	4 000	40	0,385	STRFB032TRCT
40	29,0	5,5	4 000	24	0,599	STRFB040TRCT
50	36,2	6,9	4 000	16	0,941	STRFB050TRCT
63	45,8	8,6	4 000	12	1,471	STRFB063TRCT

Trubka FIBER BASALT PLUS S 4 / SDR 9 PN 22 (výpočet)

75	58,2	8,4	4 000	8	1,764	STRFB075TRCT
90	69,8	10,1	4 000	4	2,546	STRFB090TRCT
110	85,4	12,3	4 000	4	3,781	STRFB110TRCT
125*	97,0	14,0	4 000	4	4,891	STRFB125TRCT

* výroba na zakázku, dodací lhůta 30 dnů

Trubky FIBER BASALT PLUS jsou dle tloušťky stěny označeny třídou „S“. Zastaralé označování trubek „PN“ nelze pro nový materiál PP-RCT použít, neboť trubky z tohoto materiálu mají lepší provozní parametry (tlak, teplota, životnost) než trubky z PPR.

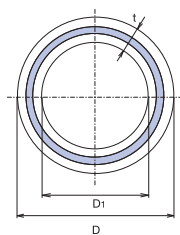

Trubka FIBER BASALT KLIMA 20 – 25 mm S 4 / SDR 9, PN 22 (výpočet)

D mm	D ₁ mm	t mm	l mm	Balení m	Váha kg/m	KÓD
20	14,4	2,3	4 000	100	0,128	STRFBC020TRCT
25	18,0	2,8	4 000	60	0,199	STRFBC025TRCT

Trubka FIBER BASALT KLIMA 32 – 125 mm S 5 / SDR 11, PN 18 (výpočet)

32	26,2	2,9	4 000	40	0,269	TTRFBC032TRCT
40	32,6	3,7	4 000	24	0,428	TTRFBC040TRCT
50	40,8	4,6	4 000	16	0,664	TTRFBC050TRCT
63	51,4	5,8	4 000	12	1,050	TTRFBC063TRCT
75*	61,4	6,8	4 000	8	1,501	TTRFBC075TRCT
90*	73,6	8,2	4 000	4	2,122	TTRFBC090TRCT
110*	90,0	10,0	4 000	4	3,160	TTRFBC110TRCT
125*	102,2	11,4	4 000	4	4,082	TTRFBC125TRCT

* výroba na zakázku, dodací lhůta 30 dnů

Trubky FIBER BASALT KLIMA jsou dle tloušťky stěny označeny třídou „S“. Zastaralé označování trubek „PN“ nelze pro nový materiál PP-RCT použít, neboť trubky z tohoto materiálu mají lepší provozní parametry (tlak, teplota, životnost) než trubky z PPR. K dispozici pouze v zelené barvě.

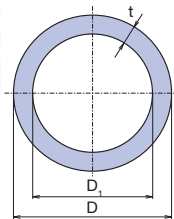

Trubka v kole

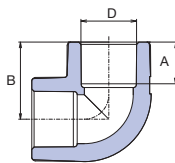
D mm	S (PN) mm	SDR mm	t mm	I mm	Balení v kole	Váha kg/m	KÓD 100 m	KÓD 200 m
16	3,2 (16)	7,4	2,2	100 / 200	1	0,094	STRK016P17	STRK016P16
20	5,0 (10)	11	2,2	100 / 200	1	0,121	STRK020P11	STRK020P10
20	3,2 (16)	7,4	2,8	100 / 200	1	0,145	STRK020P17	STRK020P16
16	2,5 (20)	6	2,7	100 / 200	1	0,107	STRK016P21	STRK016P20
20	2,5 (20)	6	3,4	100 / 200	1	0,169	STRK020P21	STRK020P20

Koleno 90°

D mm	A mm	B mm	Balení I.	Balení II.	Váha kg/ks	KÓD
16	13,0	23,2	50	250	0,010	SKO01690XX
20	14,5	26,8	50	500	0,018	SKO02090XX
25	16,0	31,0	50	250	0,030	SKO02590XX
32	18,0	36,5	25	150	0,056	SKO03290XX
40	20,5	43,0	10	70	0,100	SKO04090XX
50	23,5	51,0	10	40	0,158	SKO05090XX
63	27,5	61,5	5	15	0,334	SKO06390XX
75	30,0	70,1	2	6	0,558	SKO07590XX
90	33,0	82,0	1	5	1,010	SKO09090XX
110	37,0	95,0	1	1	1,344	SKO11090XX
125*	40,0	105,0	1	1	1,640	SKO12590XX

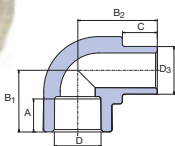
* informace o dodací lhůtě na vyžádání

Koleno 90° vnitřní / vnější

D, D ₃ mm	A mm	B ₁ mm	B ₂ mm	C mm	Balení I.	Balení II.	Váha kg/ks	KÓD
16	13,0	21,3	25,0	12,0	50	50	0,006	SKO116XXXX
20	14,5	26,8	30,3	13,0	50	250	0,014	SKO120XXXX
25	16,0	31,0	35,0	14,0	50	200	0,024	SKO125XXXX
32	18,0	36,5	42,2	16,0	25	100	0,044	SKO132XXXX

Rozvody studené (pitné) vody, teplé vody a vytápění (standardní, I.)

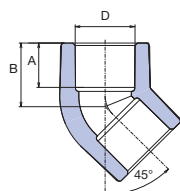

Koleno 45°

D mm	A mm	B mm	Balení		Váha kg/ks	KÓD
			I.	II.		
16	13,0	18,7	50	50	0,008	SKO01645XX
20	14,5	20,8	100	500	0,014	SKO02045XX
25	16,0	24,0	50	250	0,024	SKO02545XX
32	18,0	27,0	20	80	0,042	SKO03245XX
40	20,5	31,5	5	25	0,082	SKO04045XX
50	23,5	36,5	5	20	0,122	SKO05045XX
63	27,5	43,0	5	10	0,280	SKO06345XX
75	30,0	48,1	2	6	0,406	SKO07545XX
90	33,0	54,1	1	6	0,654	SKO09045XX
110	37,0	62,1	1	1	0,965	SKO11045XX

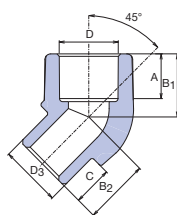

Koleno 45° vnitřní / vnější

D mm	D ₃ mm	A mm	B ₁ mm	B ₂ mm	C mm	Balení		Váha kg/ks	KÓD
						I.	II.		
16	16	13,0	18,7	18,7	12,0	50	50	0,008	SKO11645XX
20	20	14,5	20,8	21,5	13,0	10	100	0,012	SKO12045XX
25	25	16,0	24,0	24,0	14,0	10	100	0,026	SKO12545XX

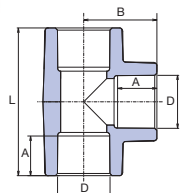

T-kus jednoznačný

D mm	A mm	B mm	L mm	Balení		Váha kg/ks	KÓD
				I.	II.		
16	13,0	23,2	46,4	50	50	0,012	STK016XXXX
20	14,5	27,0	54,0	50	300	0,022	STK020XXXX
25	16,0	32,0	60,0	50	200	0,038	STK025XXXX
32	18,0	35,7	70,0	20	100	0,070	STK032XXXX
40	20,5	38,5	86,2	10	50	0,124	STK040XXXX
50	23,5	51,0	102,0	5	30	0,196	STK050XXXX
63	27,5	61,5	123,0	5	15	0,430	STK063XXXX
75	30,0	70,1	140,2	1	5	0,644	STK075XXXX
90	33,0	83,1	166,2	1	1	1,134	STK090XXXX
110	37,0	99,1	198,2	1	1	1,962	STK110XXXX
125*	40,0	105,0	210,0	1	1	2,030	STK125XXXX

* informace o dodací lhůtě na vyžádání

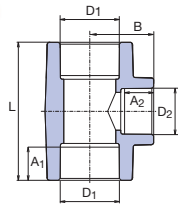

T-kus redukovaný

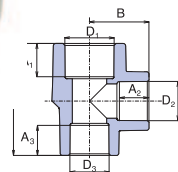
D ₁ mm	D ₂ mm	A ₁ mm	A ₂ mm	L mm	B mm	Balení I.	Balení II.	Váha kg/ks	KÓD
20	16	14,5	13,0	53,0	23,0	50	50	0,018	STKR02016X
25	20	16,0	14,5	55,0	29,0	50	200	0,032	STKR02520X
32	20	18,0	14,5	67,0	34,4	50	150	0,052	STKR03220X
32	25	18,0	16,0	73,0	34,4	25	100	0,062	STKR03225X
40	20	20,5	14,5	64,5	38,0	20	60	0,082	STKR04020X
40	25	20,5	16,0	66,0	40,2	10	50	0,090	STKR04025X
40	32	20,5	18,0	86,0	41,5	10	40	0,132	STKR04032X
50	25	23,5	16,0	77,0	43,4	5	15	0,138	STKR05025X
50	32	23,5	18,0	84,0	46,0	5	30	0,152	STKR05032X
50	40	23,5	20,5	91,4	47,4	5	15	0,176	STKR05040X
63	25	27,5	16,0	85,0	49,9	5	10	0,239	SKTR06325X
63	32	27,5	18,0	92,0	52,0	5	15	0,290	STKR06332X
63	40	27,5	20,5	100,0	54,6	5	15	0,306	STKR06340X
63	50	27,5	23,5	110,0	57,2	5	15	0,340	STKR06350X

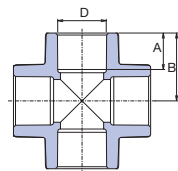

T-kus dvousměrně redukovaný

D ₁ mm	D ₂ mm	D ₃ mm	A ₁ mm	A ₂ mm	A ₃ mm	L mm	B mm	Balení I.	Balení II.	Váha kg/ks	KÓD
25	20	20	16,0	14,5	14,5	55,2	29,3	10	50	0,028	STKR0252020
32	20	20	18,0	14,5	14,5	57,3	32,8	10	50	0,040	STKR0322020
32	20	25	18,0	14,5	16,0	58,9	32,8	10	50	0,044	STKR0322520
32	25	25	18,0	18,0	16,0	66,0	34,4	10	50	0,052	STKR0322525

* informace o dodací lhůtě na vyžádání

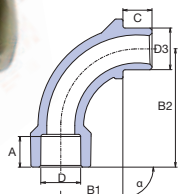

Kříž

D mm	A mm	B mm	Balení I.	Balení II.	Váha kg/ks	KÓD
20	14,5	26,3	25	25	0,024	SKRI020XXX
25	16,0	30,1	25	25	0,042	SKRI025XXX
32	18,0	35,0	10	40	0,070	SKRI032XXX
40	20,5	42,0	10	30	0,128	SKRI040XXX

Oblouk

D mm	D ₃ mm	A mm	B ₁ mm	B ₂ mm	C mm	α mm	Balení I.	Balení II.	Váha kg/ks	KÓD
20	20	14,5	37,0	56,0	13,6	90°	25	100	0,022	SO02090XXX
25	25	16,0	45,0	67,0	14,6	90°	10	100	0,036	SO02590XXX

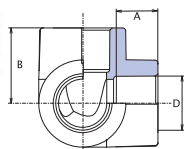
Rozvody studené (pitné) vody, teplé vody a vytápění (standardní, I.)



Koleno trojcestné

D	A	B	Balení	Balení	Váha	KÓD
mm	mm	mm	I.	II.	kg/ks	
20	14,5	26,8	10	50	0,020	SKOT020XXX
25	16,0	29,5	10	40	0,032	SKOT025XXX
32	18,0	35,0	5	20	0,062	SKOT032XXX
40	20,5	41,5	5	15	0,108	SKOT040XXX

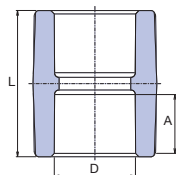

Nátrubek

D	A	L	Balení	Balení	Váha	KÓD
mm	mm	mm	I.	II.	kg/ks	
16	13,0	33,0	50	50	0,006	SNA016XXXX
20	14,5	34,6	50	500	0,010	SNA020XXXX
25	16,0	37,8	50	250	0,018	SNA025XXXX
32	18,0	40,0	25	150	0,034	SNA032XXXX
40	20,5	48,0	20	80	0,056	SNA040XXXX
50	23,5	53,0	10	70	0,082	SNA050XXXX
63	27,5	65,0	5	30	0,118	SNA063XXXX
75	30,0	73,4	1	5	0,314	SNA075XXXX
90	33,0	79,2	1	1	0,470	SNA090XXXX
110	37,0	88,2	1	1	0,782	SNA110XXXX
125*	40,0	86,0	1	1	0,745	SNA125XXXX

* informace o dodací lhůtě na vyžádání

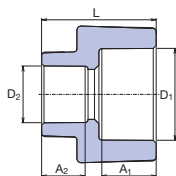

Redukce hrdlová

D ₁	D ₂	A ₁	A ₂	L	Balení	Balení	Váha	KÓD
mm	mm	mm	mm	mm	I.	II.	kg/ks	
25	20	16,0	14,5	34,0	50	450	0,014	SRE02520XX
32	20	18,0	14,5	39,0	50	250	0,026	SRE03220XX
32	25	18,0	16,0	39,5	50	250	0,028	SRE03225XX

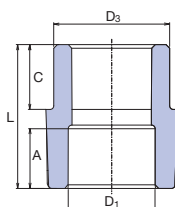
Redukce vnitřní / vnější

D₃ mm	D₁ mm	A mm	L mm	C mm	Balení I.	Balení II.	Váha kg/ks	KÓD
20	16	13,0	32,5	13,0	50	50	0,006	SRE12016XX
25	20	14,5	34,0	14,0	50	500	0,010	SRE12520XX
32	20	14,5	40,0	16,0	50	200	0,016	SRE13220XX
32	25	16,0	39,5	16,0	50	300	0,018	SRE13225XX
40	20	14,5	47,0	18,5	10	50	0,024	SRE14020XX
40	25	16,0	45,4	18,5	10	50	0,026	SRE14025XX
40	32	18,0	48,2	18,5	20	60	0,034	SRE14032XX
50	25	16,0	41,3	21,3	10	50	0,042	SRE15025XX
50	32	18,0	55,5	22,0	10	50	0,052	SRE15032XX
50	40	20,5	52,0	22,0	10	50	0,048	SRE15040XX
63	25	16,0	49,3	25,3	5	10	0,070	SRE16325XX
63	32	18,0	62,5	25,3	5	10	0,080	SRE16332XX
63	40	20,5	58,5	25,3	5	10	0,078	SRE16340XX
63	50	23,5	58,5	25,3	5	10	0,078	SRE16350XX
75	40	20,5	64,5	28,9	5	20	0,116	SRE17540XX
75	50	23,5	64,5	28,9	5	20	0,120	SRE17550XX
75	63	27,5	71,5	33,4	1	5	0,210	SRE17563XX
90	63	27,5	64,5	33,4	1	1	0,221	SRE19063XX
90	75	30,0	78,0	34,0	1	1	0,290	SRE19075XX
110	75	30,0	60,0	39,4	1	1	0,268	SRE111075X
110	90	33,0	87,0	39,4	1	1	0,502	SRE111090X
125*	110	40,0	100,3	42,4	1	1	0,678	SRE1125110

* informace o dodací lhůtě na vyžádání

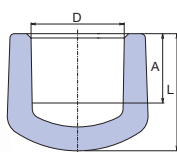
Záslepka

D mm	A mm	L mm	Balení I.	Balení II.	Váha kg/ks	KÓD
16	13,5	20,9	50	50	0,004	SZA016XXXX
20	14,5	24,5	50	150	0,008	SZA020XXXX
25	16,0	28,0	50	150	0,014	SZA025XXXX
32	18,0	33,0	20	100	0,026	SZA032XXXX
40	20,5	39,5	5	25	0,048	SZA040XXXX
50	23,5	47,0	5	25	0,078	SZA050XXXX
63	27,5	53,5	5	5	0,170	SZA063XXXX
75	30,0	60,0	5	5	0,262	SZA075XXXX
90	33,0	69,0	1	1	0,425	SZA090XXXX
110	37,0	79,0	1	1	0,715	SZA110XXXX

Rozvody studené (pitné) vody, teplé vody a vytápění (standardní, I.)

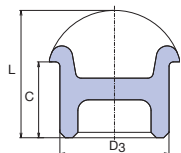

Záslepka vnitřní

D ₃ mm	C mm	L mm	Balení I.	Balení II.	Váha kg/ks	KÓD
20	14,3	23,5	40	160	0,004	SZA120XXXE

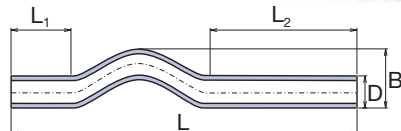

Křížení S 2,5 / PN 20 / SDR 6

D mm	S (PN 20) mm	B mm	L mm	L ₁ mm	L ₂ mm	Balení I.	Balení II.	Váha kg/ks	KÓD
16	2,5 (20)	35,0	400,0	80,0	180,0	10	10	0,044	SKR016P20X
20	2,5 (20)	47,0	400,0	80,0	180,0	10	50	0,070	SKR020P20X
25	2,5 (20)	52,0	400,0	80,0	120,0	10	50	0,110	SKR025P20X
32	2,5 (20)	65,0	390,0	64,0	106,0	5	20	0,174	SKR032P20X
40	2,5 (20)	65,0	390,0	64,0	106,0	5	20	0,268	SKR040P20X

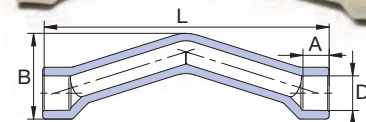
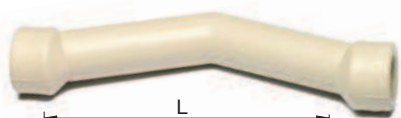

Křížení hrdlové

D mm	S (PN 20) mm	A mm	B mm	L mm	Balení I.	Balení II.	Váha kg/ks	KÓD
20	2,5 (20)	14,5	33,4	160,0	10	50	0,041	SKRH020P20
25	2,5 (20)	16,0	44,2	200,0	10	50	0,089	SKRH025P20

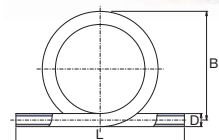
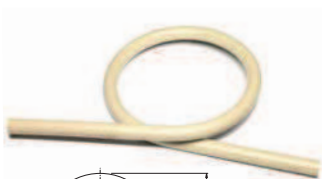

Kompenzační smyčka S 2,5 / PN 20 / SDR 6

D mm	S (PN 20) mm	B mm	L mm	Balení	Váha kg/ks	KÓD
16	2,5 (20)	185,0	320,0	10	0,090	SKS016P20X
20	2,5 (20)	200,0	450,0	10	0,174	SKS020P20X
25	2,5 (20)	210,0	440,0	10	0,264	SKS025P20X
32	2,5 (20)	230,0	410,0	5	0,430	SKS032P20X
40	2,5 (20)	290,0	450,0	3	0,786	SKS040P20X

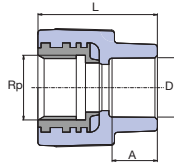

Přechodka s kovovým závitem vnitřním

D	Rp	A	L	Balení	Balení	Váha	KÓD
mm		mm	mm	I.	II.	kg/ks	
16	1/2"	13,0	38,0	10	50	0,050	SZI01620XX
20	1/2"	14,5	39,0	10	250	0,056	SZI02020XX
20	3/4"	14,5	42,0	10	100	0,072	SZI02025XX
25	1/2"	16,0	40,5	10	50	0,062	SZI02520XX
25	3/4"	16,0	47,0	10	100	0,075	SZI02525XX
32	3/4"	18,0	45,0	10	30	0,081	SZI03225XX
32*	1"	18,0	57,0	10	60	0,148	SZI03232OK
40*	5/4"	20,5	65,0	5	10	0,260	SZI04040XX
50*	6/4"	23,5	69,0	4	4	0,328	SZI05050XX
63*	2"	27,5	76,0	2	2	0,616	SZI06363XX

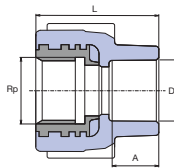
* s osmihranem (8)

Přechodka s kovovým závitem vnitřním s křížem

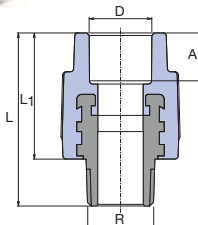
D	Rp	A	L	Balení	Balení	Váha	KÓD
mm		mm	mm	I.	II.	kg/ks	
20	1/2"	14,5	42,0	10	100	0,058	SZI02020KX

Přechodka s kovovým závitem vnějším

D	R	A	L	L ₁	Balení	Balení	Váha	KÓD
mm		mm	mm	mm	I.	II.	kg/ks	
16	1/2"	13,0	52,0	37,5	10	50	0,064	SZE01620XX
20	1/2"	14,5	53,5	39,0	10	150	0,062	SZE02020XX
20	3/4"	14,5	58,0	40,0	10	100	0,096	SZE02025XX
25	1/2"	16,0	55,5	41,0	10	60	0,066	SZE02520XX
25	3/4"	16,0	59,0	41,0	20	100	0,098	SZE02525XX
32	3/4"	18,0	60,0	44,0	10	30	0,105	SZE03225XX
32	1"	18,0	62,5	46,0	10	60	0,170	SZE03232XX
32*	1"	18,0	69,5	42,0	10	60	0,204	SZE03232OK
40*	5/4"	20,5	80,0	48,0	5	10	0,312	SZE04040XX
50*	6/4"	23,5	81,6	54,0	4	4	0,460	SZE05050XX
63*	2"	27,5	101,0	63,5	2	2	0,758	SZE06363XX
75*	2½"	30,0	110,0	69,7	1	1	1,150	SZE07575XX
90*	3"	33,0	130,0	85,0	1	1	1,774	SZE09090XX

* s osmihranem (8)

Rozvody studené (pitné) vody, teplé vody a vytápění (standardní, I.)



Přechodka kov s převlečnou maticí

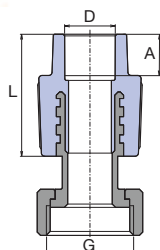

D mm	G	A mm	L mm	Balení I.	Balení II.	Váha kg/ks	KÓD
16	1/2"	13,0	32,0	10	10	0,044	SZM01620XX
16	3/4"	13,0	32,0	10	10	0,082	SZM01625XX
20	1/2"	14,5	40,0	20	100	0,048	SZM02020XX
20	3/4"	14,5	39,0	20	100	0,082	SZM02025XX
20	1"	14,5	39,0	5	10	0,152	SZM02032XX
25	3/4"	16,0	41,1	20	100	0,086	SZM02525XX
25	1"	16,0	41,0	4	4	0,154	SZM02532XX
32	5/4"	18,0	48,0	2	2	0,254	SZM03240XX

PMD převlečná matice s dírou pro plombu

20	3/4"	14,5	39,0	10	10	0,084	SZMD02025X
----	------	------	------	----	----	-------	------------



Koleno 90° s kovovým závitem vnitřním

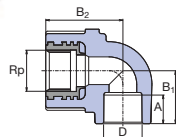

D mm	Rp	A mm	B ₁ mm	B ₂ mm	Balení I.	Balení II.	Váha kg/ks	KÓD
16	1/2"	13,0	25,2	31,0	10	50	0,062	SKOI01620X
20	1/2"	14,5	27,0	34,5	10	100	0,062	SKOI02020X
20	3/4"	14,5	27,0	40,0	10	50	0,082	SKOI02025X
25	1/2"	16,0	31,0	36,0	10	50	0,070	SKOI02520E
25	3/4"	16,0	30,0	41,0	10	100	0,090	SKOI02525X
32	1"	18,0	36,0	51,0	5	50	0,168	SKOI03232X



Koleno 90° s kovovým závitem vnějším

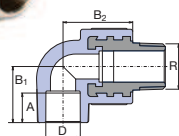

D mm	R	A mm	B ₁ mm	B ₂ mm	Balení I.	Balení II.	Váha kg/ks	KÓD
16	1/2"	13,0	25,2	31,0	10	50	0,074	SKOE01620X
20	1/2"	14,5	27,0	34,5	10	100	0,074	SKOE02020X
20	3/4"	14,5	27,0	39,0	10	50	0,112	SKOE02025X
25	1/2"	16,0	31,0	36,0	10	50	0,082	SKOE02520E
25	3/4"	16,0	30,0	39,0	10	80	0,116	SKOE02525X
32	1"	18,0	36,0	41,6	5	40	0,118	SKOE03232X



Nátrubek s výpustným ventilem vnitřní / vnější

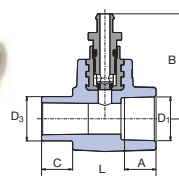

D mm	D ₃ mm	A mm	L mm	B mm	C mm	Balení I.	Balení II.	Váha kg/ks	KÓD
20	20	14,5	53,0	48,0	13,0	10	20	0,054	SNAVV120XX
25	25	16,0	54,0	49,7	14,0	5	15	0,064	SNAVV125XX
32	32	18,0	59,0	53,2	16,0	5	10	0,084	SNAVV132XX

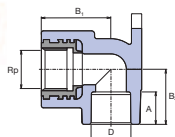
Nástěnné koleno

D	Rp	A	B ₁	B ₂	Balení	Balení	Váha	KÓD
mm		mm	mm	mm	I.	II.	kg/ks	
16	1/2"	13,0	32,0	23,2	10	60	0,064	SNK016XXXX
20	1/2"	14,5	34,0	26,8	10	150	0,068	SNK020XXXX
25	1/2"	16,0	36,0	27,5	10	50	0,072	SNK02520XX
25	3/4"	16,0	39,0	29,5	10	50	0,098	SNK025XXXX

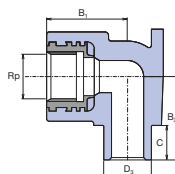
Nástěnné koleno vnitřní

D ₃	Rp	B ₁	B ₂	C	Balení	Balení	Váha	KÓD
mm		mm	mm	mm	I.	II.	kg/ks	
20	1/2"	35,0	35,0	11,0	10	120	0,068	SNK120XXXX

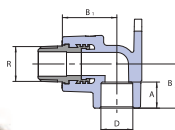
Nástěnné koleno vnější

D ₃	Rp	B ₁	B ₂	A	Balení	Balení	Váha	KÓD
mm		mm	mm	mm	I.	II.	kg/ks	
20	1/2"	34,0	32,2	14,5	10	50	0,072	SNKE02020X

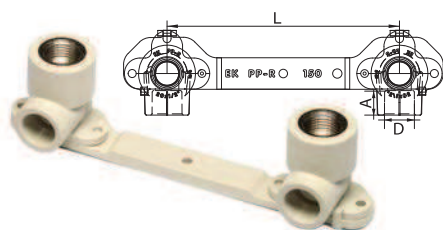
Nástěnná kolena s držákem

D	Rp	A	L	Balení	Balení	Váha	KÓD
mm		mm	mm	I.	II.	kg/ks	
20	1/2"	14,5	150	10	50	0,162	SNKD02020X

Držák nástěnných kolien

D	L	Balení	Balení	Váha	KÓD
mm	mm	I.	II.	kg/ks	
20	150	10	50	0,026	SDNKXXXXXX

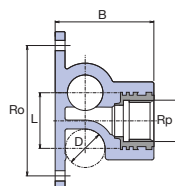

Průchozí nástěnka

D	A	Rp	B	Ro	L	Balení	Balení	Váha	KÓD
mm	mm		mm	mm	mm	I.	II.	kg/ks	
20	14,5	1/2"	50,0	66,0	28,5	20	100	0,080	SNKP020XXX
25	16,0	1/2"	56,0	76,0	33,5	10	50	0,090	SNKP02520X

Rozvody studené (pitné) vody, teplé vody a vytápění (standardní, I.)

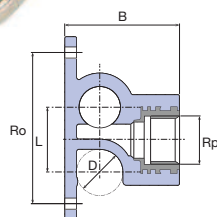

Koncové nástěnné koleno pravé



D	A	Rp	B	Ro	L	Balení	Balení	Váha	KÓD
mm	mm	mm	mm	mm	mm	I.	II.	kg/ks	
20	14,5	1/2"	50,0	66,0	28,5	5	25	0,066	SNK020KPXX



Koncové nástěnné koleno levé

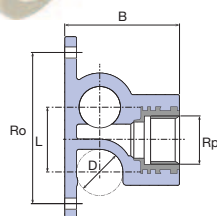

D	A	Rp	B	Ro	L	Balení	Balení	Váha	KÓD
mm	mm	mm	mm	mm	mm	I.	II.	kg/ks	
20	14,5	1/2"	50,0	66,0	28,5	5	25	0,066	SNK020KLXX



Univerzální nástěnný komplet

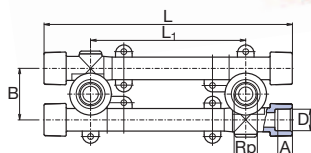

D	Rp	A	B	L ₁ *	L	Balení	Balení	Váha	KÓD
mm	mm	mm	mm	mm	mm	I.	II.	kg/ks	
20	1/2"	14,5	46,0	105/130/145	229,0	1	10	0,220	SNKK020XXX
25	1/2"	16,0	51,0	110/125/140	230,0	1	10	0,268	SNKK025XXX

* L₁ – pro rozteče 100, 135, 150 mm, nutno vyrovnat pomocí etážek

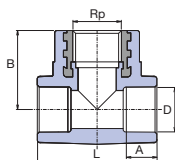
T-kus s kovovým závitem vnitřním

D	Rp	A	L	B	Balení I.	Balení II.	Váha kg/ks	KÓD
mm		mm	mm	mm				
20	1/2"	14,5	51,5	34,0	10	100	0,068	STKI02020X
25	1/2"	16,0	80,0	40,0	10	100	0,076	STKI02520X
25	3/4"	16,0	80,0	40,0	5	30	0,094	STKI02525X
32	1/2"	18,0	71,0	40,5	5	25	0,106	STKI03220X
32	3/4"	18,0	71,0	42,0	5	25	0,118	STKI03225X
32	1"	18,0	80,0	55,0	5	20	0,186	STKI03232X

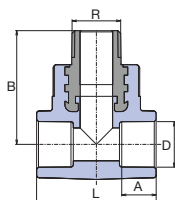
T-kus s kovovým závitem vnějším

D	R	A	L	B	Balení I.	Balení II.	Váha kg/ks	KÓD
mm		mm	mm	mm				
20	1/2"	14,5	51,5	48,5	10	100	0,080	STKE02020X
20	3/4"	14,5	60,0	50,0	5	30	0,118	STKE02025X
25	1/2"	16,0	60,0	51,0	10	80	0,088	STKE02520X
25	3/4"	16,0	65,0	52,5	5	25	0,122	STKE02525X
32	3/4"	18,0	71,0	58,3	5	20	0,146	STKE03225X
32	1"	18,0	80,0	60,0	5	20	0,208	STKE03232X

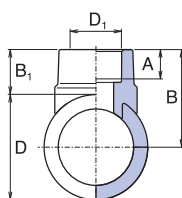

Navařovací sedlo

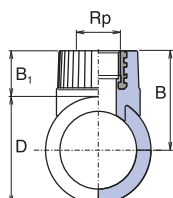
D	D ₁	A	B ₁	B	Balení I.	Balení II.	Váha kg/ks	KÓD
mm	mm	mm	mm	mm				
63	32	18,0	27,0	58,5	10	50	0,034	SNS06332XX
75	32	18,0	27,0	64,5	10	50	0,032	SNS07532XX
90	32	18,0	27,0	72,0	10	50	0,034	SNS09032XX
110	32	18,0	25,7	80,7	5	40	0,044	SNS11032XX
110	40	21,0	25,7	80,7	5	40	0,048	SNS11040XX

Navařovací sedlo s kovovým závitem vnitřním

D	Rp	B ₁	B	Balení I.	Balení II.	Váha kg/ks	KÓD
mm		mm	mm				
63	3/4"	27,0	58,5	10	10	0,084	SNSI06325X
75	3/4"	27,0	64,5	10	10	0,084	SNSI07525X
90	3/4"	27,0	72,0	10	10	0,084	SNSI09025X

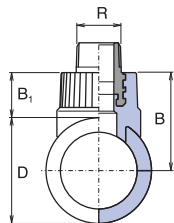
Rozvody studené (pitné) vody, teplé vody a vytápění (standardní, I.)



Navarovací sedlo s kovovým závitem vnějším

D	R	B ₁	B	Balení	Balení	Váha	KÓD
mm		mm	mm	I.	II.	kg/ks	
63	3/4"	44,8	76,3	10	10	0,112	SNSE06325X
75	3/4"	44,8	82,3	10	10	0,110	SNSE07525X
90	3/4"	44,8	89,8	10	10	0,110	SNSE09025X

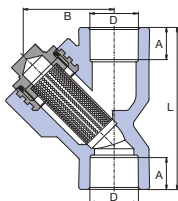

Filtr

D	B	L	A	Balení	Balení	Váha	KÓD
mm	mm	mm	mm	I.	II.	kg/ks	
20	45,0	76,0	14,5	5	40	0,116	SFI020XXXX
25	45,0	82,0	16,0	5	40	0,134	SFI025XXXX
32	55,0	95,0	18,0	5	40	0,234	SFI032XXXX

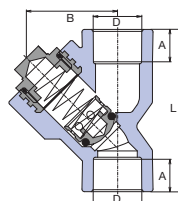

Zpětná klapka

D	B	L	A	Balení	Balení	Váha	KÓD
mm	mm	mm	mm	I.	II.	kg/ks	
20	45,0	76,0	14,5	5	40	0,136	SZKL020XXX
25	45,0	82,0	16,0	5	40	0,154	SZKL025XXX
32	55,0	95,0	18,0	5	40	0,266	SZKL032XXX

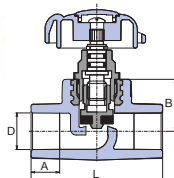

Ventil přímý plastový

D	A	B	L	Balení	Balení	Váha	KÓD
mm	mm	mm	mm	I.	II.	kg/ks	
20	14,5	27,5	69,0	10	50	0,140	SVE020XXXX
25	16,0	30,0	80,0	10	30	0,192	SVE025XXXX
32	18,0	39,0	89,0	5	15	0,380	SVE032XXXX
40	20,5	41,0	112,0	5	5	0,542	SVE040XXXX
50	23,5	48,0	136,0	1	1	0,732	SVE050XXXX
63	27,5	60,0	162,0	1	1	1,330	SVE063XXXX

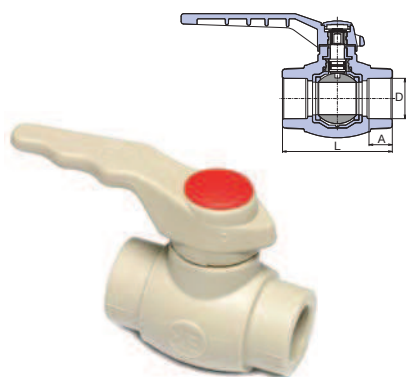
Kohout kulový plastový

D	A	L	Balení	Balení	Váha	KÓD
mm	mm	mm	I.	II.	kg/ks	
16	13,0	59,5	10	50	0,092	SVEK016XXX
20	14,5	65,0	10	50	0,116	SVEK020XXX
25	16,0	71,0	10	40	0,168	SVEK025XXX
32	18,0	85,0	10	20	0,294	SVEK032XXX
40	20,5	100,0	5	10	0,544	SVEK040XXX
50	23,5	115,0	1	5	0,874	SVEK050XXX
63	27,5	134,0	1	5	1,278	SVEK063XXX

Podomítkový ventil přímý s kovovou krytkou

D	A	B	L	Balení	Balení	Váha	KÓD
mm	mm	mm	mm	I.	II.	kg/ks	
20	14,5	27,5	69,0	5	20	0,208	SVEPLK020X
25	16,0	30,0	80,0	5	20	0,270	SVEPLK025X

Podomítkový ventil přímý s kovovou rukojetí

D	A	B	L	Balení	Balení	Váha	KÓD
mm	mm	mm	mm	I.	II.	kg/ks	
20	14,5	27,5	69,0	5	20	0,338	SVEPLR020X
25	16,0	30,0	80,0	5	20	0,392	SVEPLR025X

Ventilové prodloužení D 20, 25 mm

Balení	Váha	KÓD
	kg/ks	
1	0,071	VEPL020XXX

Prodloužení pro podomítkové ventily přímé Ø 20 a 25 mm

Podomítkový kohout kulový s kovovou krytkou

D	A	B	L	Balení	Balení	Váha	KÓD
mm	mm	mm	mm	I.	II.	kg/ks	
20	14,5	67,0	65,0	5	20	0,254	SVEKPLK020
25	16,0	65,0	71,0	5	20	0,334	SVEKPLK025

Rozvody studené (pitné) vody, teplé vody a vytápění (standardní, I.)

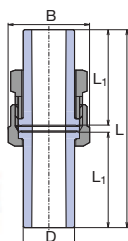

Rozebíratelný spoj

D	B	L	L ₁	Balení I.	Balení II.	Váha kg/ks	KÓD
20	30,0	82,0	40,0	20	100	0,088	SRS020XXXX
25	38,0	82,0	40,0	20	100	0,142	SRS025XXXX
32	46,0	92,0	45,0	10	50	0,212	SRS032XXXX
40	58,0	112,0	55,0	5	5	0,288	SRS040XXXX

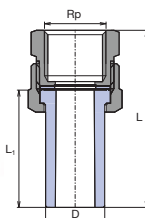

Šroubení vnitřní

D	Rp	L	L ₁	Balení I.	Balení II.	Váha kg/ks	KÓD
20	1/2"	60,0	40,0	10	100	0,086	SSI02020XX
25	3/4"	62,0	40,0	10	70	0,136	SSI02525XX
32	1"	70,0	45,0	10	50	0,220	SSI03232XX

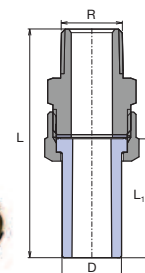

Šroubení vnější

D	R	L	L ₁	Balení I.	Balení II.	Váha kg/ks	KÓD
20	1/2"	77,0	40,0	10	100	0,118	SSE02020XX
25	3/4"	80,0	40,0	10	50	0,196	SSE02525XX
32	1"	92,0	45,0	10	40	0,324	SSE03232XX

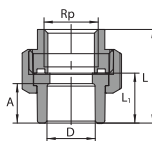

Šroubení hrdlové vnitřní

D	Rp	L	L ₁	Balení I.	Balení II.	Váha kg/ks	KÓD
20	1/2"	37,5	19,5	10	100	0,122	SSH102020X
25	3/4"	46,5	23,0	10	70	0,213	SSH102525X

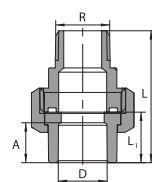

Šroubení hrdlové vnější

D	R	L	L ₁	Balení I.	Balení II.	Váha kg/ks	KÓD
20	1/2"	52,5	19,5	10	100	0,142	SSHE02020X
25	3/4"	59,0	23,0	10	70	0,223	SSHE02525X

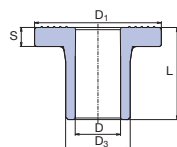

Lemový nákrůžek

D ₃ mm	L mm	D ₁ mm	S mm	D mm	Balení I.	Balení II.	Váha kg/ks	KÓD
40	58,0	80,0	12,5		2	10	0,072	SLN040XXXX
50	60,0	90,0	12,5		2	10	0,102	SLN050XXXX
63	62,0	105,0	13,5		1	10	0,156	SLN063XXXX
75	73,0	123,0	14,7		1	5	0,244	SLN075XXXX
90	92,0	140,0	17,0		1	1	0,400	SLN090XXXX
110	103,0	160,0	19,0		1	1	0,618	SLN110XXXX

Lemový nákrůžek hrdlový

165	63,0	188,0	20,0	125*	1	1	0,697	SLN125XXXX
-----	------	-------	------	------	---	---	-------	------------

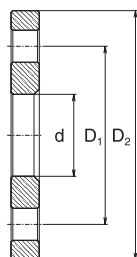
* informace o dodací lhůtě na vyžádání

Volná příruba

Typ	D ₁ mm	D ₂ mm	d mm	Y* mm	Balení	Váha kg/ks	KÓD
40 / DN32	100,0	140,0	46,0	4	1	1,660	PRI040NXXX
50 / DN40	110,0	150,0	54,0	4	1	1,802	PRI050NXXX
63 / DN50	125,0	165,0	66,0	4	1	2,414	PRI063NXXX
75 / DN65	145,0	185,0	83,0	8	1	2,978	PRI075NXXX
90 / DN80	160,0	200,0	94,0	8	1	3,490	PRI090NXXX
110 / DN100	180,0	220,0	114,0	8	1	4,098	PRI110NXXX
125 / DN150	210,0	250,0	166,0	8	1	4,450	PRI125NXXX

* Y – počet děr

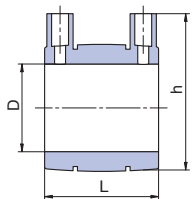
Elektrospojka

D mm	L mm	h mm	Balení	Váha kg/ks	KÓD
20	70	52	1	0,04	ENA020PPRCT
25	70	58	1	0,05	ENA025PPRCT
32	70	65	1	0,07	ENA032PPRCT
40	85	75	1	0,10	ENA040PPRCT
50	88	87	1	0,16	ENA050PPRCT
63	98	100	1	0,26	ENA063PPRCT
75	125	114	1	0,41	ENA075PPRCT
90	146	130	1	0,51	ENA090PPRCT
110	155	144	1	0,80	ENA110PPRCT
125*	166	167	1	0,95	ENA125PPRCT

* informace o dodací lhůtě na vyžádání

Svařování elektrosvářečkou s manuálním nastavením nebo elektrosvářečkou s načítáním čárového kódu, viz strana 35.

Tvarovky pro sádrokarton (standardní, I.)



Přechodka pro sádrokarton

D	Rp	A	C	L	Balení	Balení	Váha	KÓD
mm		mm	mm	mm	I.	II.	kg/ks	
20	1/2"	14,5	26,0	40,5	1	10	0,102	SZS02020XX

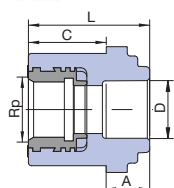

Nástěnné koleno pro sádrokarton

D	Rp	A	B ₁	B ₂	C	Balení	Balení	Váha	KÓD
mm		mm	mm	mm	mm	I.	II.	kg/ks	
20	1/2"	15	44,0	27,0	26,0	1	10	0,114	SNKS020SXX

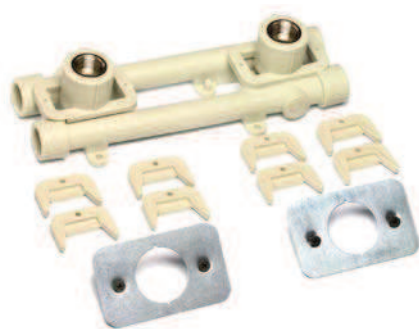
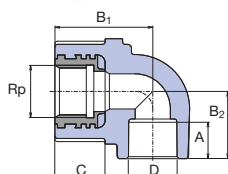

Nástěnný komplet pro sádrokarton s přesnými roztečemi

D	Rp	A	B	L ₁	C	L	Balení	Váha	KÓD
mm		mm	mm	mm	mm	mm		kg/ks	
20	1/2"	14,5	49,0	100/135/150	26,0	234,0	10	0,320	SNKK020SXX

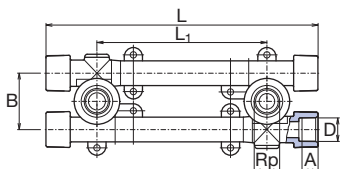

Speciální tvarovky pro vytápění (standardní, I.)

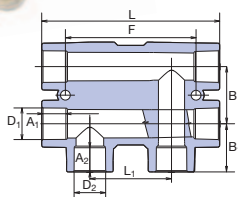
Radiátorová odbočka

D ₁	A ₁	D ₂	A ₂	L ₁	L	B ₁	B	Balení I.	Balení II.	kg/ks	KÓD
20	14,5	20	14,5	50	109	29,5	35	1	20	0,098	SRAO02020X
25	16,0	20	14,5	50	115	32,0	45	1	20	0,138	SRAO02520X

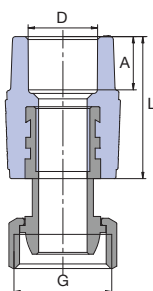
Eurokonus

D	G	A	L	Balení I.	Balení II.	kg/ks	KÓD
20	3/4"	14,5	40,0	5	25	0,089	SZM02025EX

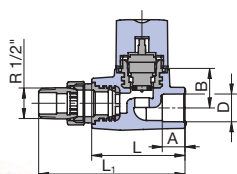
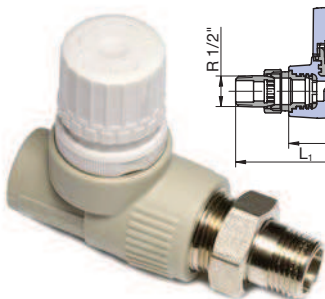
Radiátorový termostatický ventil přímý

D	A	B	L	L ₁	R	Balení I.	Balení II.	kg/ks	KÓD
20	14,5	27,5	65	102	1/2"	5	20	0,265	SVER020PXX

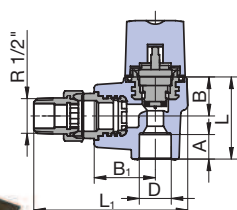
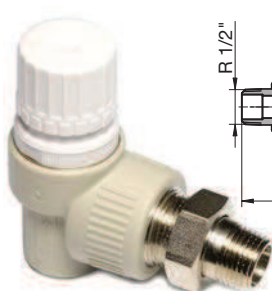
Radiátorový termostatický ventil rohový

D	A	B	B ₁	L	L ₁	R	Balení I.	Balení II.	kg/ks	KÓD
20	14,5	23,5	36,5	49,5	93	1/2"	5	20	0,269	SVER020RXX

Speciální tvarovky pro vytápění (standardní, I.)



Termostatická hlavice

Balení I.	Balení II.	kg/ks	KÓD
5	20	0,126	TEHLAXXXX

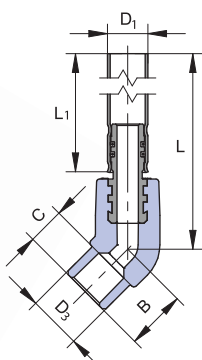

Připojení k radiátoru – koleno 45°

D ₁ mm	D ₃ mm	B mm	C mm	L mm	L ₁ mm	Balení I.	Balení II.	kg/ks	KÓD
15	20	22,5	13	298	270	1	20	0,123	SKORP12045270
15	20	22,5	13	748	720	1	10	0,270	SKORP12045720

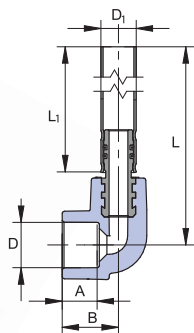

Připojení k radiátoru – koleno 90°

D mm	D ₁ mm	A mm	B mm	L mm	L ₁ mm	Balení I.	Balení II.	kg/ks	KÓD
20	15	14,5	24	300	270	1	20	0,126	SKORP02090270
20	15	14,5	24	750	720	1	10	0,273	SKORP02090720

Pouze pro rozvody pitné (studené) vody (standardní, II.)

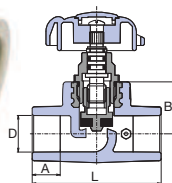

Ventil přímý plastový s výpustným ventilem

Typ	D	A	B	L	Balení	Váha	KÓD
	mm	mm	mm	mm		kg/ks	
pravý	40	20,5	41,0	112,0	1	0,578	SVEV040PXX
pravý	50	23,5	48,0	136,0	1	0,788	SVEV050PXX
pravý	63	27,5	60,0	162,0	1	1,388	SVEV063PXX
levý	40	20,5	41,0	112,0	1	0,572	SVEV040LXX
levý	50	23,5	48,0	136,0	1	0,754	SVEV050LXX
levý	63	27,5	60,0	162,0	1	1,416	SVEV063LXX

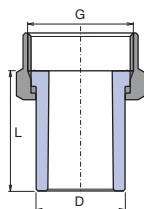
Výroba na zakázku, dodací lhůta 30 dnů

Plastové hrdlo s převlečnou maticí

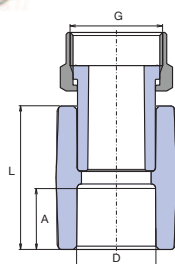
D	G	L	Balení	Balení	Váha	KÓD
mm		mm	I.	II.	kg/ks	
20	3/4"	40,0	10	100	0,048	SHM02025XX
25	1"	40,0	10	50	0,074	SHM02532XX
32	5/4"	45,0	5	25	0,096	SHM03240XX

Přechodka plastová s převlečnou maticí

D	G	A	L	Balení	Balení	Váha	KÓD
mm		mm	mm	I.	II.	kg/ks	
16	1/2"	13,0	33,0	10	50	0,032	SNAM01620X
20	1/2"	14,5	34,6	50	200	0,034	SNAM02020X
20	3/4"	14,5	34,6	25	200	0,056	SNAM02025X
25	3/4"	16,0	37,8	20	100	0,058	SNAM02525X
25	1"	16,0	37,8	10	50	0,092	SNAM02532X
32	1"	18,0	40,0	10	50	0,102	SNAM03232X

PMD – převlečná matice s dírou pro plombu

D	G	A	L	Balení	Balení	Váha	KÓD
mm		mm	mm	I.	II.	kg/ks	
20	3/4"	14,5	34,6	10	50	0,056	SNAMD02025
25	3/4"	16,0	37,8	10	50	0,062	SNAMD02525

Pouze pro rozvody pitné (studené) vody (standardní, II.)



Koleno 90° přechodka plastová s převlečnou maticí

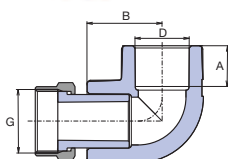

D	G	A	B	Balení	Balení	Váha	KÓD
mm		mm	mm	I.	II.	kg/ks	
20	1/2"	14,5	26,8	25	100	0,047	SKOM02020X
20	3/4"	14,5	26,8	25	100	0,062	SKOM02025X



T-kus přechodka plastová s převlečnou maticí

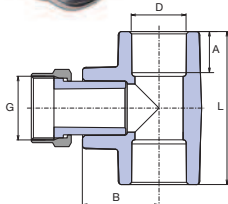

D	G	A	L	B	Balení	Balení	Váha	KÓD
mm		mm	mm	mm	I.	II.	kg/ks	
20	3/4"	14,5	54,0	27,0	10	60	0,069	STKM02025X
25	3/4"	16,0	60,0	32,0	5	50	0,079	STKM02525X
25	1"	16,0	60,0	32,0	5	30	0,157	STKM02532X
32	3/4"	18,0	70,0	35,7	5	10	0,100	STKM03225X
32	1"	18,0	70,0	35,7	5	10	0,135	STKM03232X

Pro provizorní použití (nestandardní, III.)



Přechodka s plastovým závitem vnějším

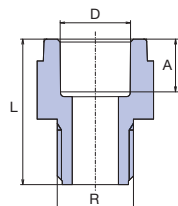

D	R	A	L	Balení	Balení	Váha	KÓD
mm		mm	mm	I.	II.	kg/ks	
20	1/2"	14,5	40,0	50	200	0,014	SDG02020XX
20	3/4"	14,5	38,0	50	50	0,012	SDG02025XX
25	3/4"	16,0	42,0	50	50	0,020	SDG02525XX
32	1"	18,0	54,0	25	25	0,038	SDG03232XX
40	5/4"	20,5	62,0	10	10	0,074	SDG04040XX
50	6/4"	23,5	63,0	10	10	0,094	SDG05050XX
63	2"	27,5	81,9	5	5	0,194	SDG06363XX

Příslušenství (IV.)

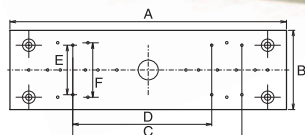
Držák nástěnek

A	B	C	D	E	F	Balení I.	Balení II.	Váha kg/ks	KÓD
220,0	64,0	135,0	110,0	45,0	40,0	10	50	0,058	DNPXXXXXX

Objímka kovová s vrutem

D mm	Balení I.	Balení II.	Váha kg/ks	KÓD
20 - 25	20	200	0,056	PRK02025XX
32 - 40	10	100	0,074	PRK03240XX
50 - 63	5	50	0,124	PRK06350XX

Objímka kovová s matkou

D mm	Matka mm	Šroub s vrutem mm	Balení I.	Balení II.	Váha kg/ks	KÓD
48 - 53	M8/10		5	50	0,078	PRKB04853X
72 - 78	M8/10		5	10	0,146	PRKB07278X
87 - 92	M8/10		5	10	0,180	PRKB08792X
102 - 116	M8/10		5	10	0,238	PRKB102116
	M8/100		10	10	0,023	VRUTM8100X

Přichytka plastová

D mm	Balení I.	Balení II.	Váha kg/ks	KÓD
16	50	300	0,004	PRE016XXXX
20	50	500	0,004	PRE020XXXX
25	50	500	0,006	PRE025XXXX
32	50	300	0,008	PRE032XXXX
40*	1	50	0,016	PRP040XXXX
50*	1	25	0,034	PRP050XXXX
63*	1	25	0,046	PRP063XXXX
75*	1	1	0,084	PRP075XXXX
90*	1	1	0,114	PRP090XXXX
110*	1	1	0,136	PRP110XXXX

* s páskem

Příslušenství (IV.)



Dvoupříchytka plastová

D mm	Balení	Váha kg/ks	KÓD
2 x 20	1	0,016	PRDV0202XX
2 x 25	1	0,022	PRDV0252XX



Svářečka trnová RSP 2a elektronická (pro nepárové nástavce)

Typ	W	Balení	Váha kg/ks	KÓD
RSP 2a	800	1	1,328	SVARSP2AXEL



Svářečka zrcadlová RSP 2aPm elektronická (pro párové nástavce)

Typ	W	Balení	Váha kg/ks	KÓD
RSP 2aPm	800	1	1,428	SVARSP2APEL



Svařovací komplet s nástavci 16-63 mm

Typ	W	Nástavce mm	Balení	Váha kg/ks	KÓD
RSP 2a	800	∅ 16 – 63	1	9,223	SVAKRSP2A6E
RSP 2aPm	800	∅ 16 – 63	1	8,645	SVAKRSP2P6E

Obsahuje nůžky PROFI, klíč, metr, stabilizační stojánek, nášlapný stojánek, nástavce a typ svářečky dle objednávky.



Svařovací komplet s nástavci 20-32 mm

Typ	W	Nástavce mm	Balení	Váha kg/ks	KÓD
RSP 2a	800	∅ 20 – 32	1	4,545	SVAKRSP2A3E
RSP 2aPm	800	∅ 20 – 32	1	4,490	SVAKRSP2P3E

Obsahuje nůžky STANDARD, klíč, stabilizační nášlapný stojánek, nástavce a typ svářečky dle objednávky.



Opravná sada

Typ	Balení	Váha kg/ks	KÓD
sada	1	0,186	OSAXXXXXXX

Sada obsahuje nástavec nepárový ∅ 12 mm a 5 ks náhradních opravných trnů ∅ 12 mm.



Opravné náhradní trny

Ø mm	Balení	Váha kg/ks	KÓD
12	1 (5)	0,029	OTXXXXXXXX

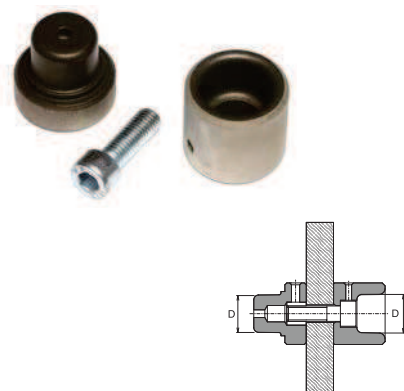

Elektrosvářečka Elektra light

Typ pro pr.	W	Balení	Váha kg/ks	KÓD
20-125/160 mm	2 000	1	8,000	SVAELEKTRAL

Na objednávku, dodací lhůta 30 dnů

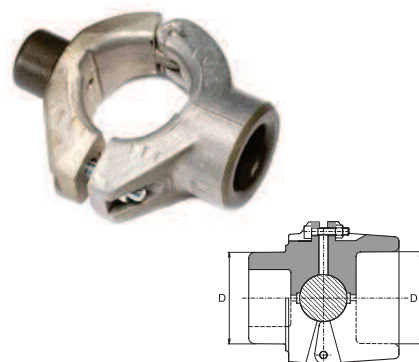

Nástavce párové

D mm	Balení	Váha kg/ks	KÓD
16	1	0,074	NAP016XXXX
20	1	0,078	NAP020XXXX
25	1	0,138	NAP025XXXX
32	1	0,164	NAP032XXXX
40	1	0,308	NAP040XXXX
50	1	0,333	NAP050XXXX
63	1	0,493	NAP063XXXX
75	1	0,653	NAP075XXXX
90	1	1,089	NAP090XXXX
110	1	1,681	NAP110XXXX
125	1	1,996	NAP125XXXX

Nástavce nepárové

D mm	Balení	Váha kg/ks	KÓD
16	1	0,130	NA016CXXXX
20	1	0,133	NA020CXXXX
25	1	0,178	NA025CXXXX
32	1	0,215	NA032CXXXX
40	1	0,379	NA040CXXXX
50	1	0,517	NA050CXXXX
63	1	0,822	NA063CXXXX

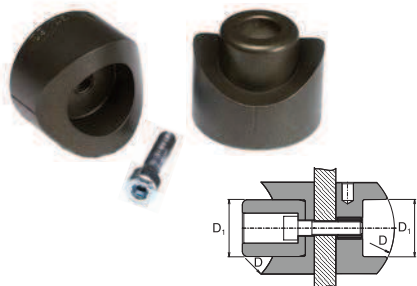
Příslušenství (IV.)



Nástavce na navařovací sedla

D mm	D ₁ mm	Balení	Váha kg/ks	KÓD
63	32	1	0,298	SNNS06332X
75	32	1	0,296	SNNS07532X
90	32	1	0,296	SNNS09032X
110*	40	1	0,432	SNNS11040X

* pro navařovací sedla Ø 110/32 a 110/40

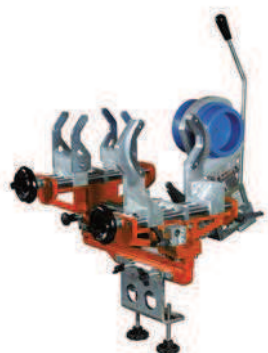

Montážní přípravek MP-125

Typ	D mm	Balení	Váha kg/ks	KÓD
MP-125	63-125	1	37,200	SVAMP125

MP 125 obsahuje základní rám, stojan se svářečkou s příkonem 1 400 W, kufřík s příslušenstvím
Na objednávku, dodací lhůta 30 dnů



Svářečka PRISMA 125 - 1 400 W

Typ	Balení	Váha kg/ks	KÓD
SVA125XX	1	2,760	SVA125XXXX

Na objednávku, dodací lhůta 30 dnů



Teploměr dotykový – DT METR

Typ	Balení	Váha kg/ks	KÓD
DT-METER pohyblivý	1	0,940	TEPODXXXXX



Utahovací klíč s páskou

Balení	Váha kg/ks	KÓD
1	0,297	UKXXXXXXXX

Nůžky PROFI

Typ	D mm	Balení	Váha kg/ks	KÓD
PROFI	do 42	1	0,383	NU042PXXXX

Nůžky PROFI M2

Typ	D mm	Balení	Váha kg/ks	KÓD
M2	do 63	1	1,241	NU063XXXXX

Nůžky STANDARD

Typ	D mm	Balení	Váha kg/ks	KÓD
STANDARD	do 42	1	0,360	NU042HSXXX

Řezák

D mm	Balení	Váha kg/ks	KÓD
50-140	1	1,420	REZ050140X

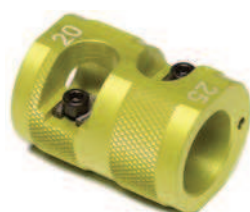
Ořezávač STABI trubek

D mm	Balení	Váha kg/ks	KÓD
16-20	1	0,134	REZS01620X
20-25	1	0,156	REZS02025X
25-32	1	0,206	REZS02532X
32-40	1	0,266	REZS03240X
50	1	0,302	REZS050XXX
63	1	0,352	REZS063XXX
75	1	0,386	REZS075XXX
90	1	0,634	REZS090XXX
110	1	0,870	REZS110XXX

Příslušenství (IV.)



Ořezávač STABI trubek do vrtačky

D mm	Balení	Váha kg/ks	KÓD
16	1	0,096	REZS016VXX
20	1	0,076	REZS020VXX
25	1	0,144	REZS025VXX
32	1	0,242	REZS032VXX
40	1	0,290	REZS040VXX
50	1	0,882	REZS050VXX
63	1	0,406	REZS063VXX
Čep			
16	1	0,020	CEPXXXXXXX



Vrták pro navařovací sedla

D mm	Balení	Váha kg/ks	KÓD
32	1	0,200	VNS032XXXX
40	1	0,300	VNS040XXXX



Žlab pozinkovaný

D mm	I mm	Balení I.	Balení II.	Váha kg/ks	KÓD
20	2 000	1	25	0,331	ZLSP20XXXX
25	2 000	1	25	0,428	ZLSP25XXXX
32	2 000	1	25	0,516	ZLSP32XXXX
40	2 000	1	25	0,607	ZLSP40XXXX
50	2 000	1	25	0,732	ZLSP50XXXX
63	2 000	1	25	0,879	ZLSP63XXXX



Zátka krátká

G	Balení I.	Balení II.	Váha kg/ks	KÓD
1/2"	50	250	0,008	ZAGXXXXXXX

Součástí zátky krátké je gumové těsnění

Zátka dlouhá

G	Balení I.	Balení II.	Váha kg/ks	KÓD
1/2"	50	250	0,022	ZAGDXXXXXX

Součástí zátky dlouhé je gumové těsnění

Těsnicí tmel SISEAL

Obsah g	Balení m	Váha kg/ks	KÓD
10	1	0,018	TMSIS10XXX
100	1	0,124	TMSIS100XX

Těsnicí teflonová nit

Balení m	Váha kg/ks	KÓD
50	0,053	TTN50XXXXX
150	0,126	TTN150XXXX

Značení trubek S (SDR) místo PN

V katalogu jsou pro snadnější orientaci uvedeny výpočtové hodnoty „PN“ pro trubky z PP-RCT (při výpočtu byl použit vzorec pro „PN“ dle normy). Provozní parametry

trubek jsou uvedeny v popisu na trubkách a v Montážním předpisu.

V souladu s normami ČSN EN ISO15874 a DIN 8077 je nutné označovat trubky „S“ nebo „SDR“ místo „PN“.

$$SDR = 2S+1$$

$$SDR \approx D/t \quad (D = \text{vnější průměr, } t = \text{tloušťka stěny})$$

- ⦿ označení „PN“ udává přípustný provozní přetlak v bar pro maximální teplotu 20 °C a životnost 50 let pro nejmenší konstrukční koeficient
- ⦿ zatřídění trubek dle „PN“ již normy ČSN EN ISO 15874 a DIN 8077 neuvádějí
- ⦿ trubky z PPR označujeme „PN“ historicky, (dřívější značení pro tlakovou řadu), přestože hodnoty výše uvedené definici již neodpovídají
- ⦿ materiál PP-RCT je nový typ materiálu, značení „PN“ nebylo zavedeno

Použité zkratky a certifikace

Wavin Ekoplastik neustále vyvíjí a vylepšuje své výrobky, proto si vyhrazuje právo na modifikace a změny specifikací svých výrobků bez předchozího uvědomění. Všechny informace obsažené v této publikaci byly připraveny v dobré víře

a s přesvědčením, že v den předání materiálů do tisku jsou aktuální a nevzbuzují pochybnosti. Současný katalog nepředstavuje nabídky ve smyslu občanského zákoníku, ale obsahuje informace o výrobcích.

- ⊙ použití a montáž výrobků se řídí montážním předpisem pro Systém Ekoplastik
- ⊙ na standardní výrobky (I., II.) je poskytována záruka 10 let
- ⊙ na ostatní výrobky (III., IV.) je poskytována záruka 2 roky
- ⊙ pro výrobu a zkoušení je používána norma ČSN EN ISO 15874
- ⊙ všechny prvky odpovídají požadavkům zákona 22/1997 Sb., a souvisejícím NV 312/2005 Sb., NV 17/2003 Sb., NV 616/2006 Sb., zákona 258/2000 Sb., vyhláše Ministerstva zdravotnictví 409/2005 Sb., v platném znění. v souladu s těmito předpisy byla vydána „prohlášení o shodě“
- ⊙ systém kvality certifikován dle ISO 9001-2009

Použité zkratky

- KÓD – objednávkový kód pro výrobek
- S (PN) – série (tlaková řada)
- Balení I. – malé Balení
- Balení II. – velké Balení
- G – vnitřní závit válcový netěsnící na závitěch
- Rp – vnitřní závit válcový těsnící na závitěch
- R – vnější závit kuželový těsnící na závitěch

